

Door Stop Seals

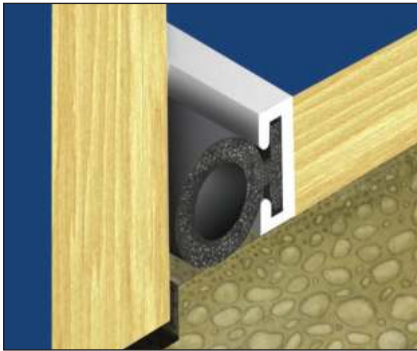

SEALMASTER MONSOON

For heavy duty door applications, roller shutter doors & sliding doors



SHS/027



SHG/026

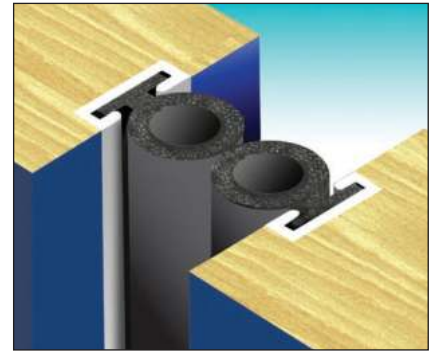

SHS/026

APPLICATIONS

A heavy duty draught and noise seal for industrial or other large applications.

FEATURES & BENEFITS





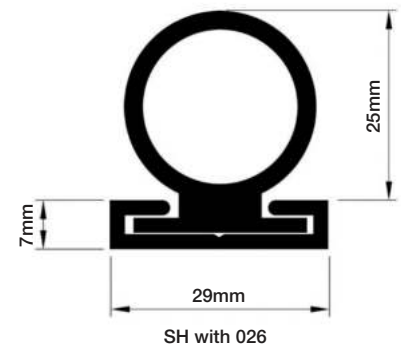
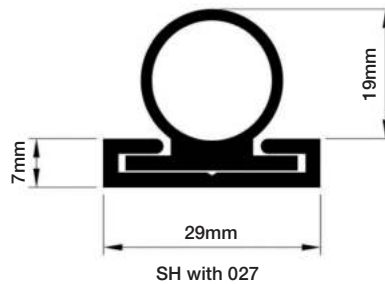
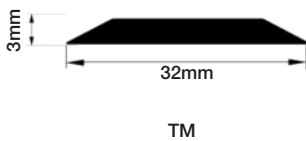

Monsoon seals are circular heavy duty draught and noise seals, particularly suitable for use in industrial applications on large doors where the gaps are consistent and for the bottom of roller shutter doors.

On roller shutter doors, these seals should make contact with a suitable threshold, such as the Thunder TMS or TMG.

HOW TO SPECIFY

e.g. Sealmaster Monsoon SHS/026 with Sealmaster Thunder TMS contact strip to suit door inmm wide opening.



Standard Options	Insert 026	Insert 027	NONE
Satin Silver - SHS 	 SHS/026	 SHS/027	
Satin Gold - SHG 	SHG/026	SHG/027	
Satin Silver - TMS 			TMS
Satin Gold - TMG 			TMG